

# MOEN®

ORDER BY PART NUMBER

## Illustrated Parts

### Karis™

One-Handle Lavatory Faucet

MODEL	HANDLE	FINISH
84346	Lever	Chrome
84346BL	Lever	Matte Black
84346SRN	Lever	Spot Resist Brushed Nickel

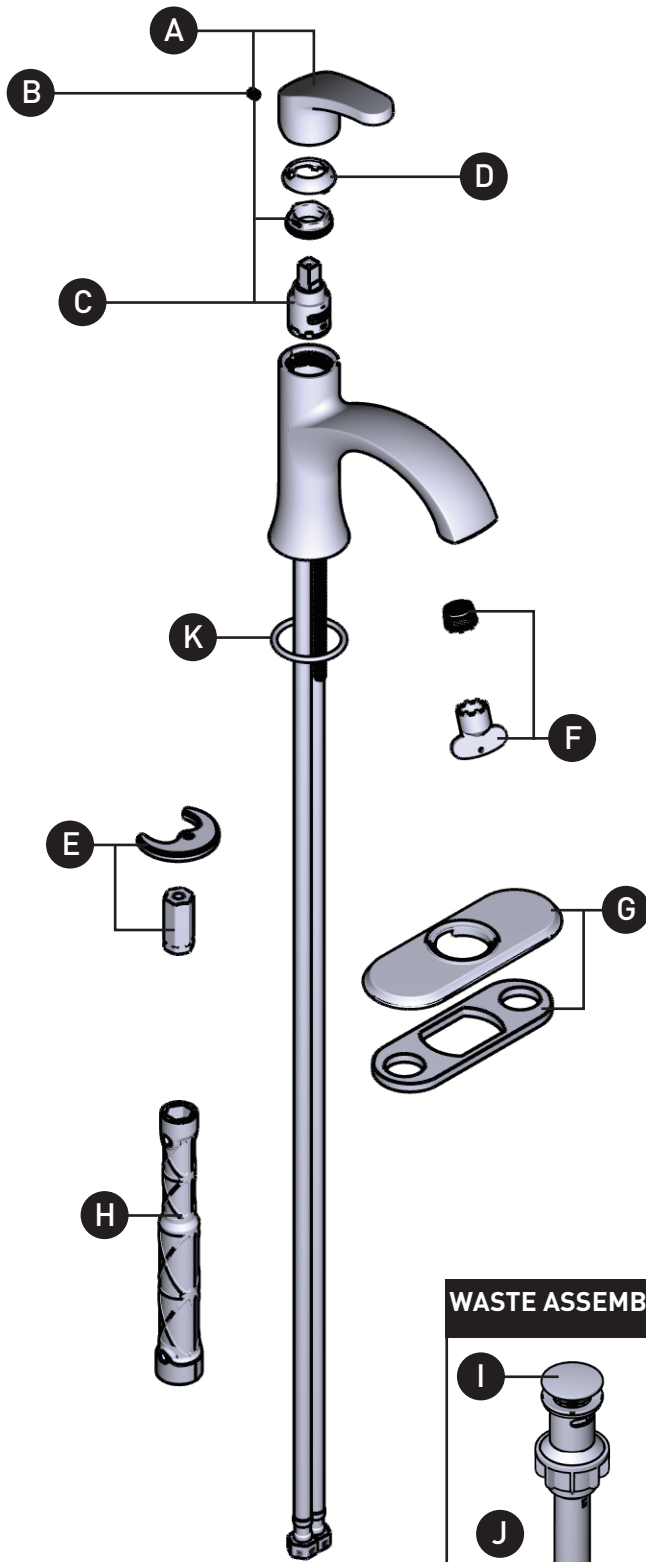

ID	Kit Number	Kit Description	Finish
A	205865	Handle Kit	Chrome
	205865BL		Matte Black
	205865SRN		Spot Resist Brushed Nickel
B	155023	Set Screw( <i>requires 3/32" hex key</i> )	N/A
C	202233	Cartridge, Cart. Nut & Set Screw	N/A
D	201724	Handle Dome	Chrome
	201724BL		Matte Black
	201724SRN		Spot Resist Brushed Nickel
E	146190	Hardware Kit	N/A
F	180158	Aerator( <i>Includes Tool</i> )	N/A
G	150568	Deck Plate Kit	Chrome
	150568BL		Matte Black
	150568SRN		Spot Resist Brushed Nickel
H	118305	Installation Tool	N/A
I	186479	Waste Assembly ( <i>Top Only</i> )	Chrome
	186479BL		Matte Black
	186479CSL		Classic Stainless
J	186478	Waste Assembly ( <i>Full Assembly</i> )	Chrome
	186478BL		Matte Black
	186478CSL		Classic Stainless
K	150567	Deck Gasket Kit	N/A