

■ Order by Part Number

HALLE™		
Two-Handle Widespread Lavatory Faucet		
MODEL	HANDLE	FINISH
84972SRN	Lever	Spot Resist Brushed Nickel

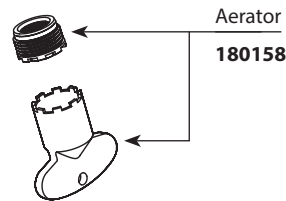
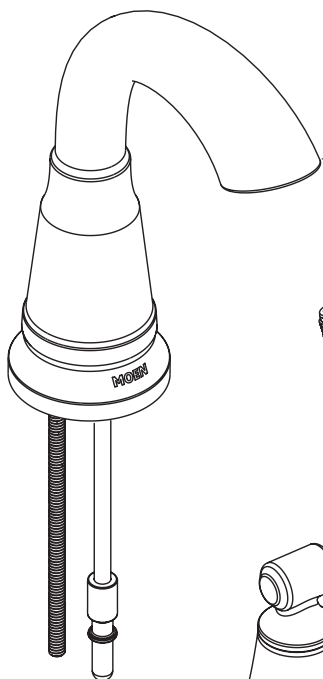
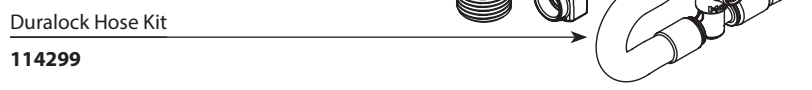
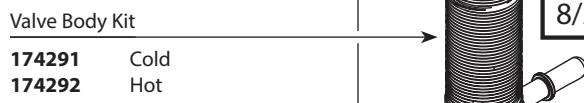
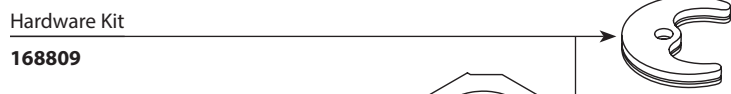
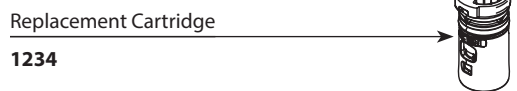
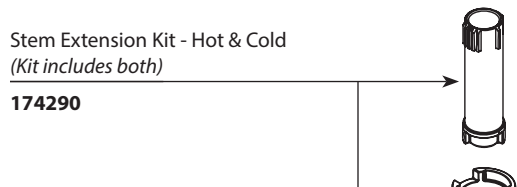
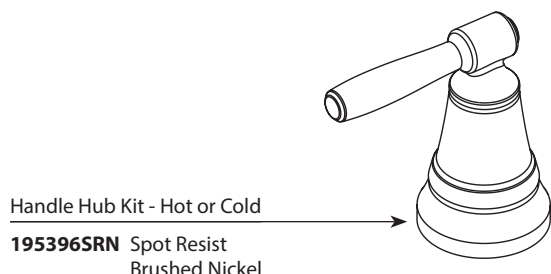
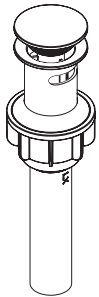

Mounting Nut
For models
prior to
8/2018

WASTE ASSEMBLIES	
For Waste Service Order Full Assembly	
Waste Assembly	
186479CSL Top only Classic Stainless (Used for Spot Resist Brushed Nickel)	
186478CSL Classic Stainless (Used for Spot Resist Brushed Nickel)	

